

Notes:	Category: ACCESS COVER & FRAME - SEALED		 FIBRELITE
	Product Description: FL140 - 1400mm x 700mm flat sealed composite cover with an aluminium frame.		
For reference purposes only. This drawing is not a specification.	Drawing No: 131401	Product Code FL140	
	Date: April 2001	Revisions: 0	

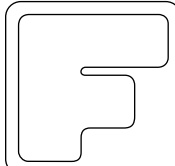

Weights	
Cover Weight:	50kg
Frame Weight:	17kg

Notes:	Category: ACCESS COVER & FRAME - SEALED	
	Product Description: FL140 - 1400mm x 700mm flat sealed composite cover with an aluminium frame.	
For reference purposes only. This drawing is not a specification.	Drawing No: 131402	Product Code: FL140
	Date: April 2001	Revisions: 0

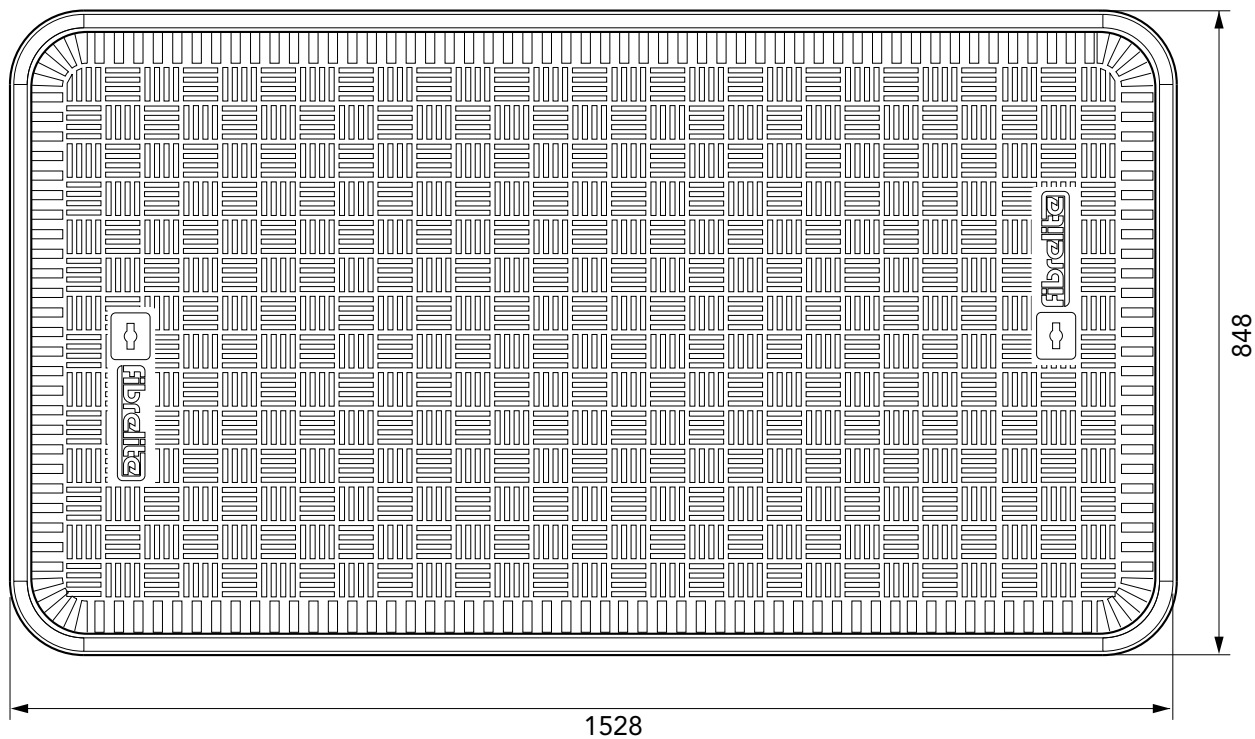
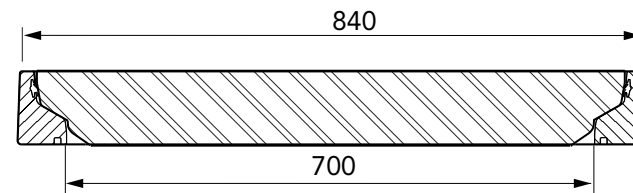
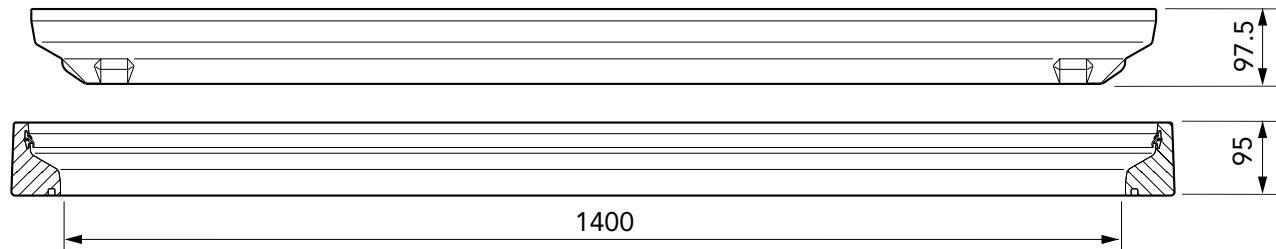
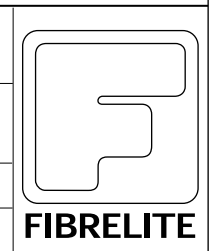

CONCRETE

VERY IMPORTANT

OUTER EDGE 'A' OF FRAME SET 5MM ABOVE GENERAL FORECOURT AREA WITH CONCRETE RAMPED AWAY OVER 300MM

VERY IMPORTANT

The underside of the frame must be adequately supported by concrete.

Expansion joint filled with petrol resistant mastic.

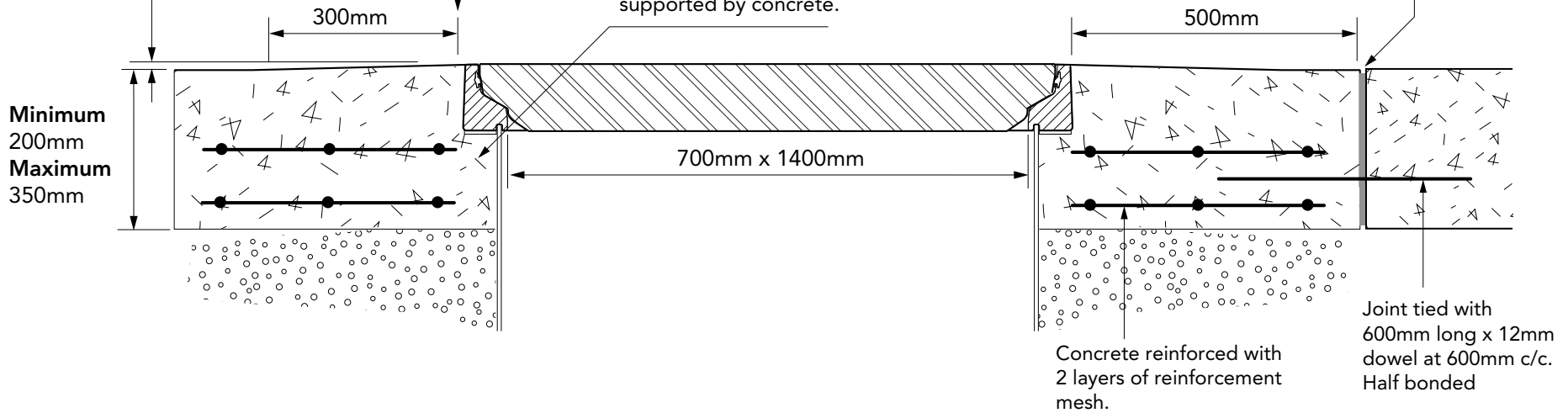

TARMACADAM

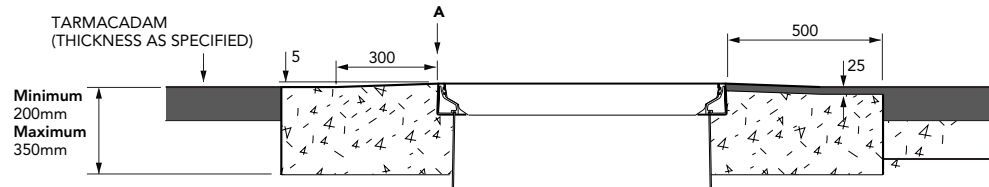

SETTS

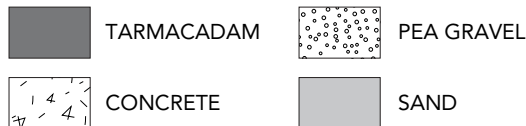
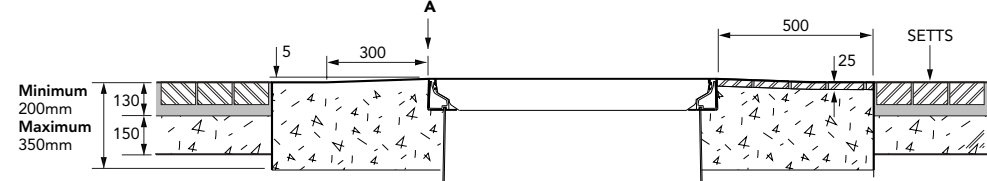

Notes:

For reference purposes only.
 This drawing is not a specification.

Category: **ACCESS COVER & FRAME - SEALED**

Product Description: **FL140 - 1400mm x 700mm flat sealed composite cover with an aluminium frame.**

Drawing No: **131403**

Date: **April 2001**

Product Code **FL140**

Revisions: **0**

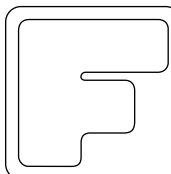

FIBRELITE