

Notes:	Category: ACCESS COVER & FRAME - RAISED	
	Product Description: FL42 - 1075mm diameter raised composite cover with an aluminium frame.	
For reference purposes only. This drawing is not a specification.	Drawing No: 11420	Product Code FL42
	Date: Mar 2000	Revisions: 0

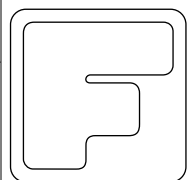

FIBRELITE

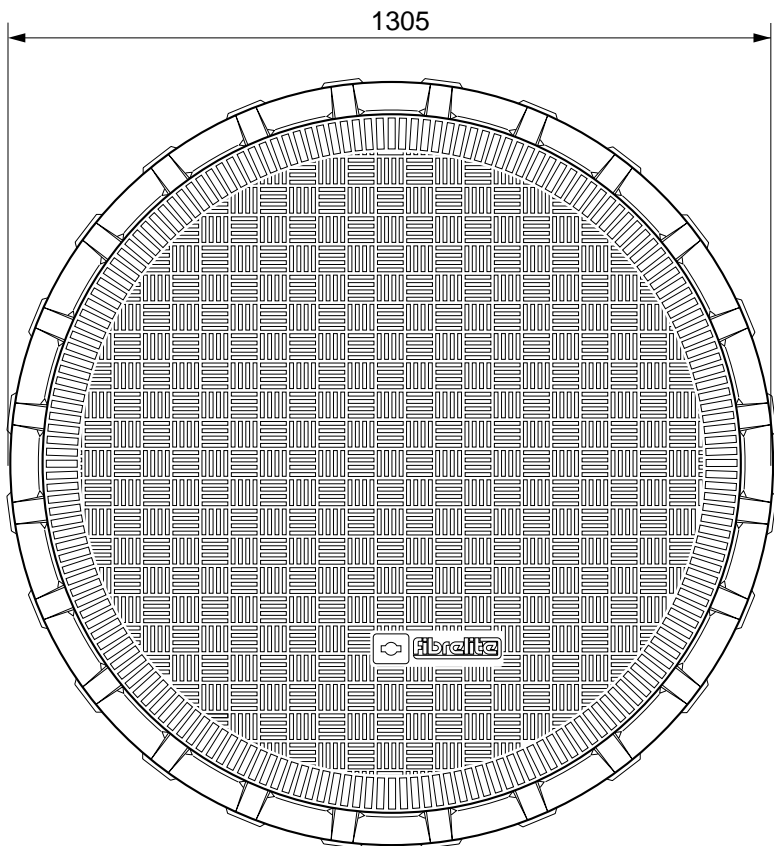
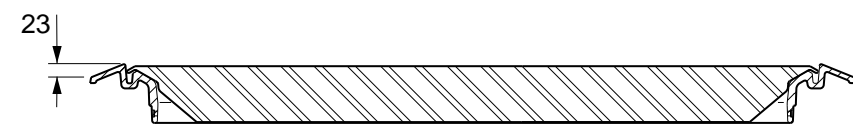
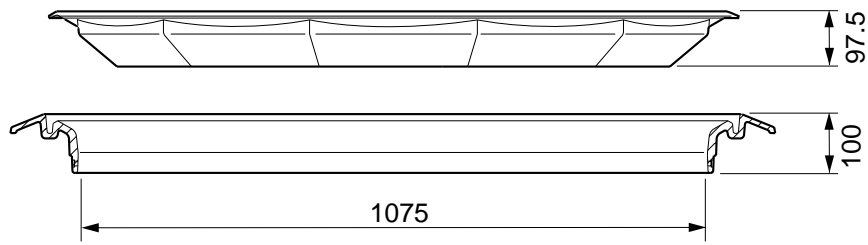

Weights	
Cover Weight:	42kg
Frame Weight:	25kg

Notes:	Category: ACCESS COVER & FRAME - RAISED	
	Product Description: FL42 - 1075mm diameter raised composite cover with an aluminium frame.	
For reference purposes only. This drawing is not a specification.	Drawing No: 11421	Product Code: FL42
	Date: Mar 2000	Revisions: 0

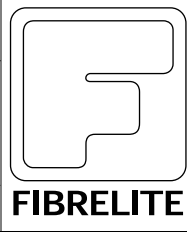

CONCRETE

VERY IMPORTANT

OUTER EDGE "A" OF FRAME SET 5 - 10MM ABOVE GENERAL FORECOURT AREA WITH CONCRETE RAMPED AWAY OVER 300MM.

VERY IMPORTANT

The underside of the frame must be adequately supported by concrete.

THIS IS THE OPERATIVE WATER CHECK IF LAID CORRECTLY

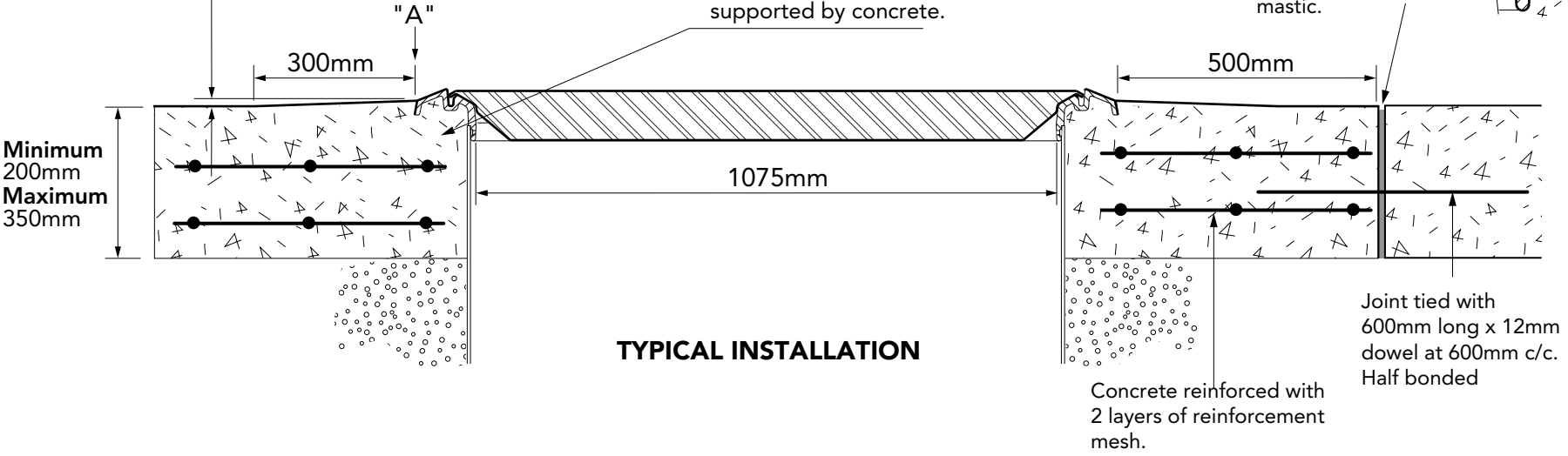
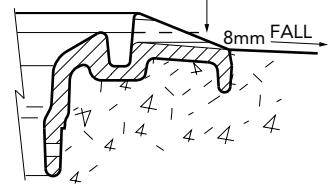



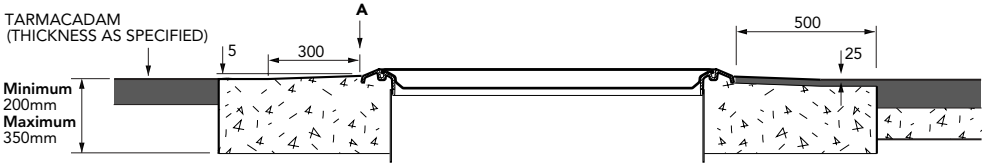

TYPICAL INSTALLATION

TARMACADAM

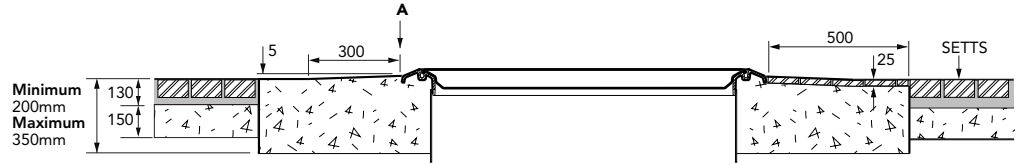

SETTS



	TARMACADAM		PEA GRAVEL
	CONCRETE		SAND

Notes:	Category: ACCESS COVER & FRAME - RAISED	
	Product Description: FL42 - 1075mm diameter raised composite cover with an aluminium frame.	
For reference purposes only. This drawing is not a specification.	Drawing No: 11422	Product Code: FL42
	Date: Mar 2000	Revisions: 0

